



## TGZGQS Series Overvoltage and Undervoltage Protector

### 1 Overview

TGZGQS self-recovery overvoltage and undervoltage protector (hereinafter referred to as the protector) is suitable for AC voltage 230V single-phase, 50Hz load line with a rated operating current of 80A and below. In case of overvoltage or undervoltage of power supply line, the protector can quickly and safely cut off the circuit under continuous high-voltage impact to avoid the abnormal voltage being transferred to the terminal electric appliance resulting in accidents. When the voltage recovers to the normal value, the protector will power on the circuit automatically within the specified time to ensure the normal operation of the terminal electric appliance during unattended operation. The product shall be connected with the circuit breaker in series, and is mainly used in the incoming splitter box and other power distribution lines to be protected in the civil and commercial buildings.

### 2 Type Designation

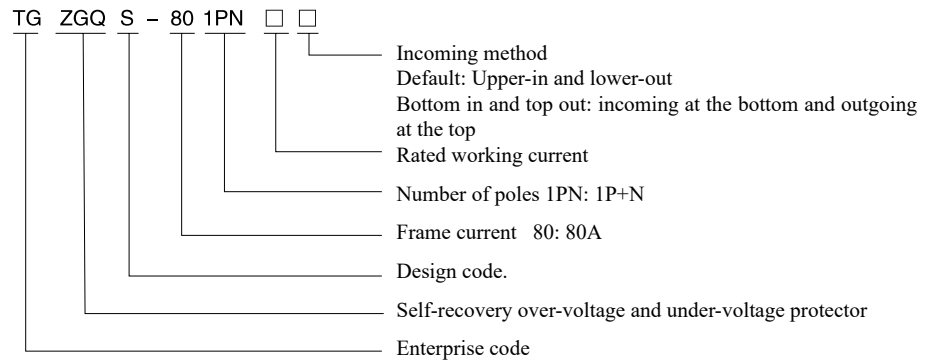



### 3 Technical Parameters

#### 3.1 Main technical parameters (see Table 1)

Table 1

Number of poles	1P+N	
Rated operating voltage $U_e$ , frequency	230V AC 50Hz	
Rated operating current $I_n$	20A、25A、32A、40A、50A、63A、80A	
Rated insulation voltage $U_i$	500V	
Rated impulse withstand voltage $U_{imp}$	4kV	
Rated limited short-circuit current capacity $I_{nc}$	6kA	
Undervoltage protection action range	50V ~ 160V	
Overvoltage protection action range	275V ~ 440V	
Undervoltage trip time	0.6s < t < 5s	
Overvoltage trip time (the trip time curve sees Fig. 1)	275V	3s < t < 15s
	300V	1s < t < 3s
	350V	0.25s < t < 0.75s
	400V	0.1s < t < 0.2s
Self-recovery voltage value	195V ~ 253V	
Self-reset forced delay	30±5s	
Electrical life	≥ 10,000 times	
Mechanical life	≥ 100,000 times	
Power	≤ 1W	

## TGZGQS Series Overvoltage and Undervoltage Protector

Work status indicator	Green light	 Normally-ON: the voltage is normal, ON
	Green light	 Fast flashing: over-voltage fault, OFF
		 Slow flashing: undervoltage fault, OFF
Protection grade	IP20	
Reference ambient temperature	30 C	
Insulation material group	II	
Incoming method	Top incoming and bottom outgoing, bottom incoming and to outgoing	
Wiring capacity	$\leq 25\text{mm}^2$ , See Table 2 for details	
Tightening torque	2.5N.m	
Dimensions (length × width × height) unit: mm	78×27×65.5	
weight	Approx. 130g	

### 3.2 Recommended cross-sectional area and rated current of the connecting wire

Table 2

Rated current A	20	25	32	40、50	63	80
Cross-sectional area of connecting wire $\text{mm}^2$	2.5	4	6	10	16	25

### 3.3 Electromagnetic compatibility (EMC)

Table 3

Anti-interference test item	Test level
Electrostatic discharge	8kV (air discharge) / 6kV (contact discharge)
Radio frequency radiation	3V/m 80MHz ~ 1,000 MHz
Transient shock	4kV 2.5kHz
Surge	$\pm 4\text{kV}$ (common mode)/ $\pm 2\text{kV}$ (differential mode)
Radio frequency conducted interference	3V 0.15 ~ 80MHz
Voltage sags and interruptions	Class 2
Approx. 130g	Approx. 130g

## TGZGQS Series Overvoltage and Undervoltage Protector

### 3.4 Overvoltage trip time curve

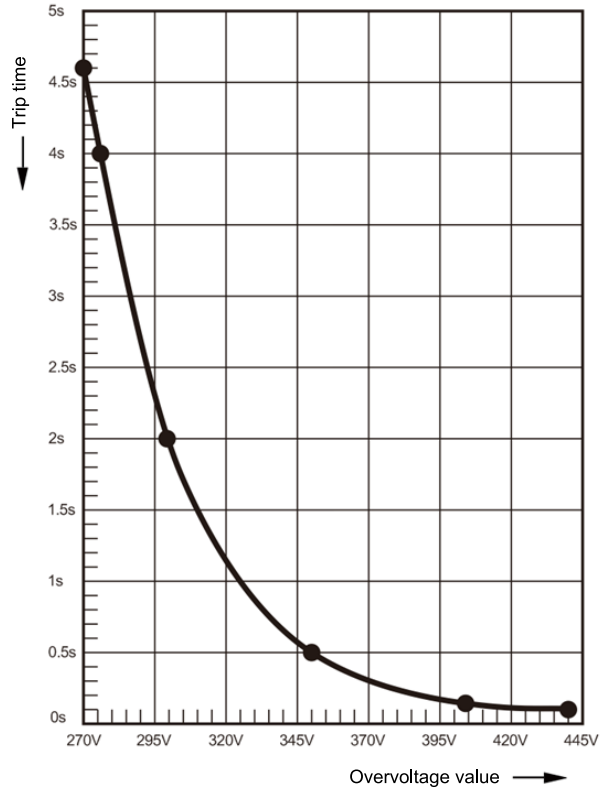

Fig. 1 Overvoltage trip time curve

## 4 Operating Conditions

Table 4

Installation category	Class II , III
Pollution degree	2
Working environment temperature (daily average temperature $\leq +35\text{ C}$ )	-25 C ~ +55 C
Storage temperature	-40 C ~ +70 C
Allowed working environment	40 C /50% RH, 20 C /90% RH
Altitude	$\leq 2,000$ meters
Installation	Installed on TH35-7.5 guide rail
Installation location	Installed at any position on the guide rail

## TGZGQS Series Overvoltage and Undervoltage Protector

### 5 Outline and Installation Dimensions

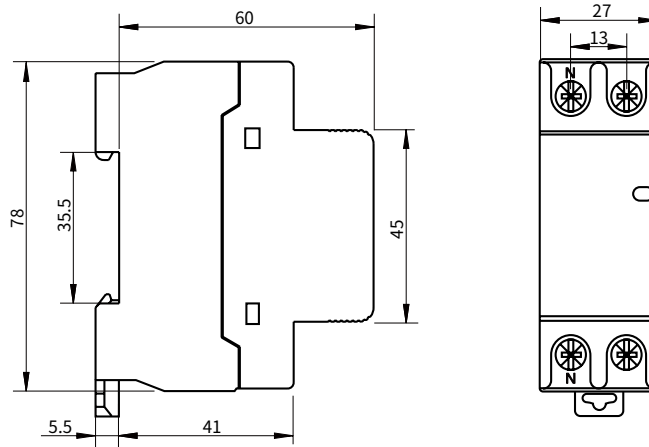
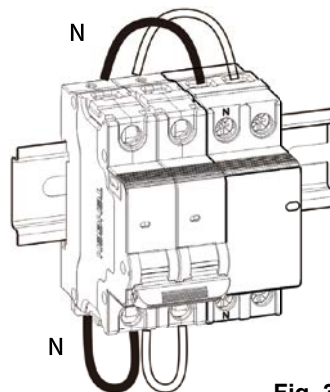

Fig. 2 Outline dimensions (mm)

### 6 Installation, Commissioning, Inspection and Maintenance

- 6.1 Before installation, check that the product mark is consistent with the conditions used. The protector has no overload and short-circuit protection functions, and the product only detects the line voltage, and must be used together with a miniature circuit breaker. The rated current of the protector shall be greater than or equal to that of the miniature circuit breaker.
- 6.2 Correctly connect the wire according to the incoming and outgoing terminals marked on the product, and tighten the fastening torque according to the rated torque to prevent the electrical failure due to poor contact. The wiring diagram sees Fig. 3.
- 6.3 Do not connect the pole N wrongly, and connect the wire reliably, otherwise the protector cannot work normally.
- 6.4 The voltage action diagram sees Fig. 4.
- 6.5 As the product has an automatic reset function, disconnect the load immediately if power outage due to protection for abnormal voltage, and check the circuit, otherwise the product will be turned on and off frequently, and eventually the product or live line will be burnt out due to frequent power-on and power-off under overload for a long time;
- 6.6 The product has no isolation function, and the superior circuit breaker must be disconnected first for inspection and maintenance.
- 6.7 Regularly tighten the terminal screws.

Top-in and bottom-out wiring diagram



Bottom-in and top-out wiring diagram

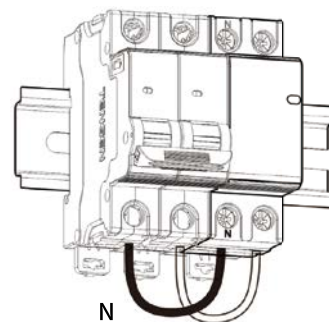

Fig. 3 Wiring diagram

## TGZGQS Series Overvoltage and Undervoltage Protector

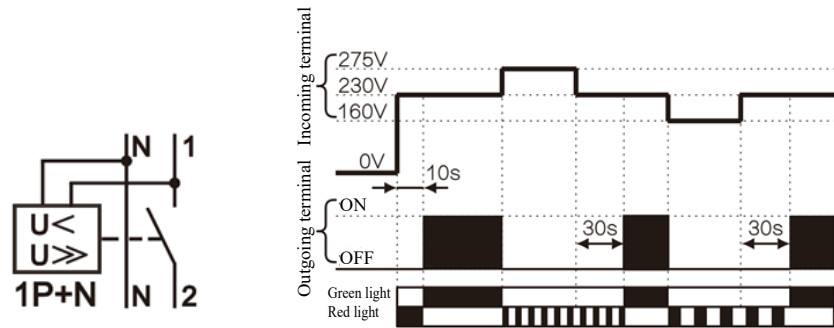

Fig. 6 Voltage action diagram

Note 1: When the protector is powered on for the first time or the system is powered on again after power outage, as there is a 10s delay due to the initialization of the internal software of the product, the red work indicator will be off after lighting up for 10s, and the green is then lit.

Note 2: After power outage, the protector will stop completely after 5s. Therefore, if the protector is powered on forcibly and the incoming terminal voltage is normal, the possible product states are as follows: the red light flashes slowly and enters the undervoltage recovery process, and the circuit will be powered on after a delay of 30s.

### 7 Fault Analysis and Troubleshooting

Table 5

Failure	Cause	Solution
The indicator (red light and green light) are not lit on	(1) Incoming and outgoing terminals are connected (2) The wiring is not firmly connected (3) Product failure	(1) Wire correctly according to the label (arrow and text), and tighten the screws. Refer to installation, commissioning, inspection and maintenance 2. (2) Repair or replacement is required if damaged due to violent drop or impact during transportation and installation.
Repeated turn off and turn on	Repeated abnormal fluctuations of the incoming terminal voltage (overvoltage or undervoltage)	Power on again after elimination of system failure. Refer to Article 6.5.
Red light flashes quickly for a long time (more than 1 minute)	Continuous over-voltage fault at the incoming line	Power on again after elimination of system failure. Refer to Article 6.5.
The incoming terminal is powered but the outgoing terminal is not powered (no output)	The voltage measured by the multimeter is normal, but the red light flashes quickly	After detecting that the voltage is normal, the switch will be turned on after a delay of 30s. Refer to Article 6.4
	The voltage measured by the multimeter is normal, but the red light flashes slowly	After detecting that the voltage is normal, the switch will be turned on after a delay of 30s. Refer to Article 6.4
	(1) Product failure (2) In case of serious overload and short-circuit fault occurred at the rear end, the end circuit breaker did not trip quickly, resulting in the product contacts are overheated and fusion welded. (3) The service life expires	(1) Repair or replacement is required if damaged due to violent drop or impact during transportation and installation. (2) Disconnect the front-end circuit breaker and the back-end load, and power on; if the fault occurs again, repair and replacement are required.
After power-on, the output terminal gives a voltage output without a 10s delay	The contact of the pole L is closed before power-on	See Note 1

Note 1: The main circuit of the protector uses a power magnetic latching relay. The contact of the pole L of the protector may be closed (open at the normal state) due to abnormal vibration or drop during transportation resulting in no delay when the product is first powered on to supply the power to the load immediately, which is abnormal phenomenon. Suggestion: please disconnect the back-end switch and load of the protector first, and power on the protector under no-load. The protector is powered off again from the normal power-on state, and then powered on again after 5s to resume the state of normal supply after a 10s delay.

## TGZGQS Series Overvoltage and Undervoltage Protector

### 8 Ordering Notice

When ordering, please specify the product model, working current specification, wiring method, and order quantity.

For example: To order 1,000 sets of TGZGQS self-recovery over-voltage protector with rated current 63A, 1P+N, bottom incoming, please specify: TGZGQS-80 1PN 63A, bottom-in and top-out, 1,000 units.

Packaging Information

Table 6

Qty.	TGZGQS-80
PCS/box	6
PCS/carton	90